

Translation of Triangles

Sheet 1

Graph the image of each triangle using the given translation.

1) 4 units down

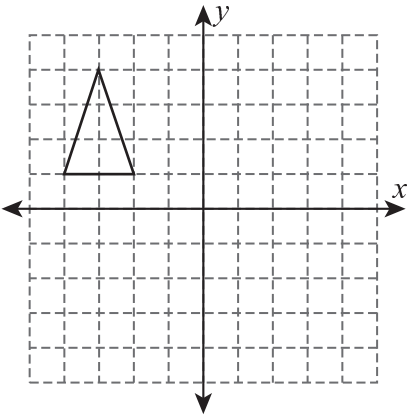

2) 6 units up and 5 units left

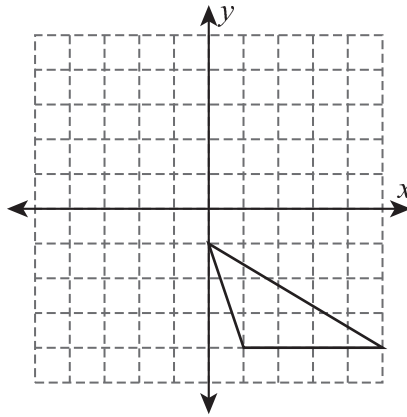

3) 5 units right and 3 units down

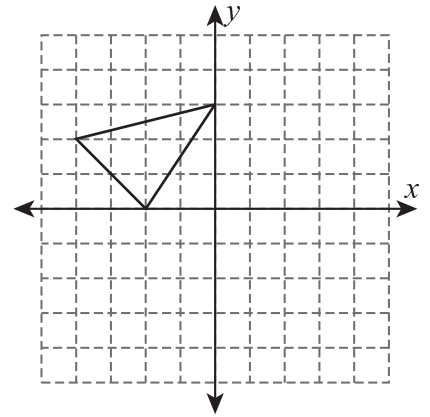

4) 5 units left and 1 unit down

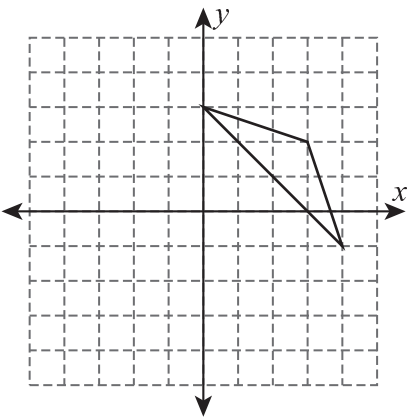

5) 7 units right and 2 units up

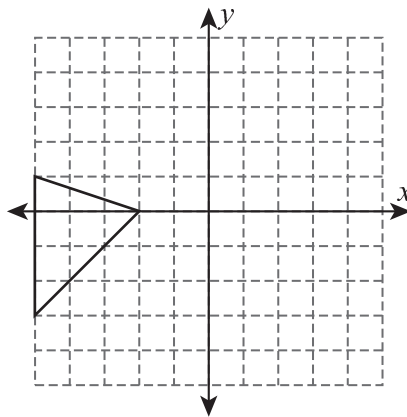

6) 3 units down and 4 units left

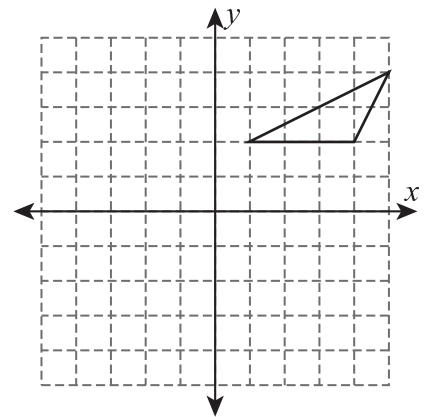

7) 2 units up and 6 units right

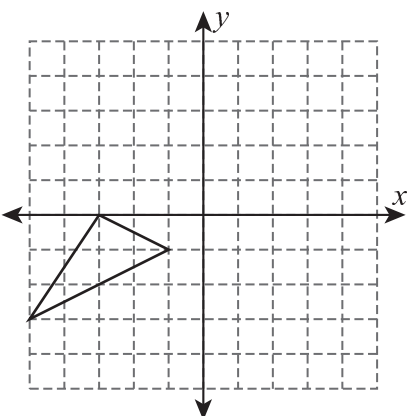

8) 4 units down and 1 unit right

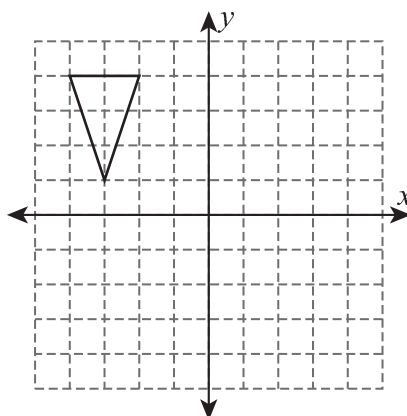

9) 8 units left and 7 units up

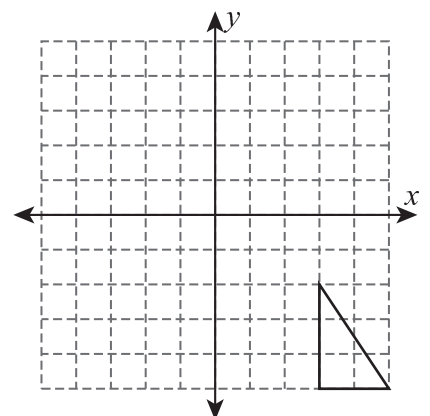

Answer key**Translation of Triangles**

Sheet 1

Graph the image of each triangle using the given translation.

1) 4 units down

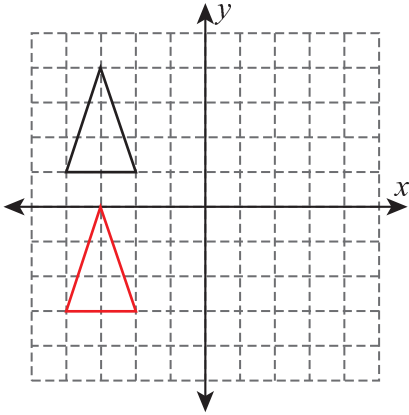

2) 6 units up and 5 units left

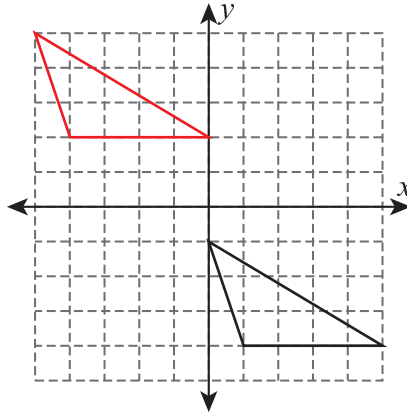

3) 5 units right and 3 units down

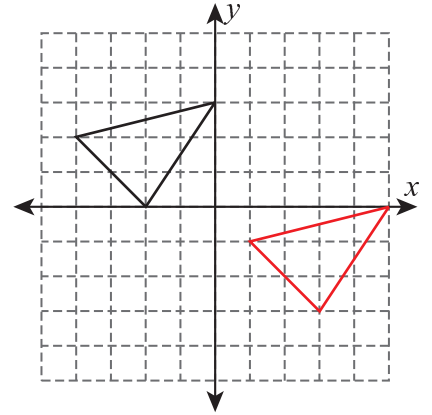

4) 5 units left and 1 unit down

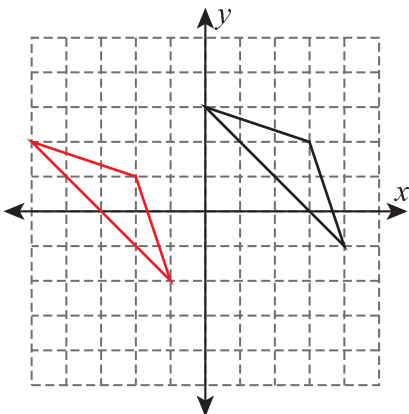

5) 7 units right and 2 units up

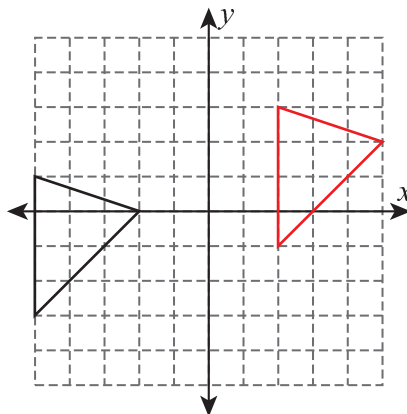

6) 3 units down and 4 units left

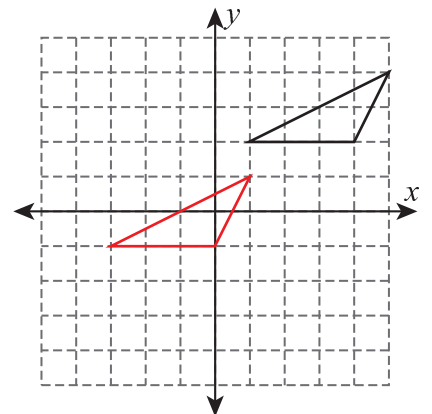

7) 2 units up and 6 units right

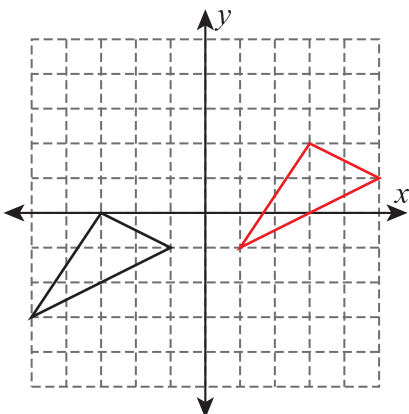

8) 4 units down and 1 unit right

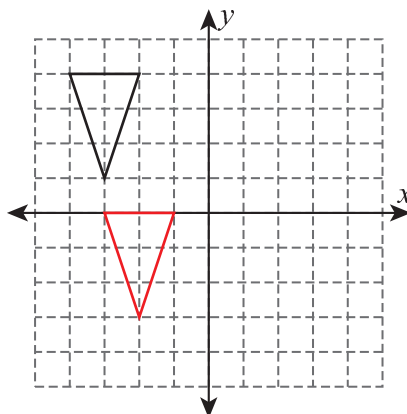

9) 8 units left and 7 units up

